

Zastosowanie:

Oświetlenie w meblach: domowych, sklepowych, aptecznych itp.
 Oświetlenie w pomieszczeniach: wkomponowane w ściany lub wykorzystane do wykonania lamp.
 Do użytku wewnętrznego i zewnętrznego w zakresie temperatur -20°C do $+65^{\circ}\text{C}$.
 Odporne na promienie UV - nie żółknie pod wpływem warunków atmosferycznych.
 Gwarancja 5 lat.

Kolory:

Opaline 2117, Semi-opaline 2118, Crystal 2070

Zalety:

Dzięki zastosowaniu elastycznego tworzywa pozwala tworzyć różne świetlne kompozycje.

Łatwość montażu.

Wskazówki:

Zalecane diody led - 14W/m 12V bez radiatora.
 - 19W/m 24V bez radiatora.

Materiał:

PCW - PVC Sha 75UV

ABS

Aluminium - AL 6060

Magnes - FER

Elastyczny dyfuzor do LED

Art.	Materiał	Wymiary
015.100.003-0	PCW	22,4 x 8,3 mm

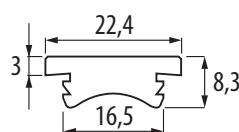

Profil do dyfuzora LED

Art.	Materiał	Wymiary
015.100.012	Aluminium	23 x 16 mm

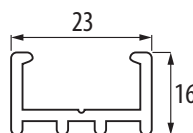

Uwaga: Może być stosowany bez profilu w wyfrezowanym kanale.
 Dedykowany profil 015.100.012.



Elastyczny dyfuzor do LED 90°

Art.	Materiał	Wymiary
015.100.004	PCW	26,5 x 14 mm

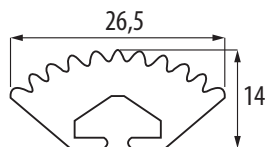

Profil do dyfuzora LED

Art.	Materiał	Wymiary
015.100.011	Aluminium	29,8 x 11,95 mm
015.100.035	Magnes	14 x 7 mm

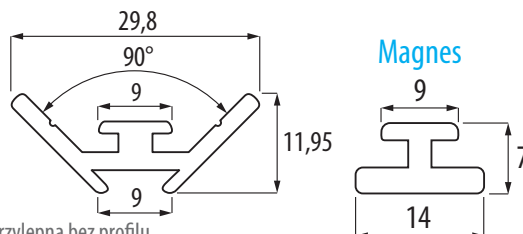

Uwaga: Może być stosowany w narożnikach na taśmę samoprzylepną bez profilu.



Elastyczny dyfuzor LED

Art.	Materiał	Wymiary
015.100.002	PCW	22,4 x 14 mm

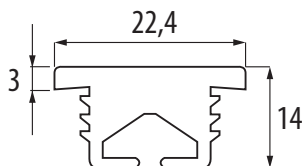

Uwaga: Profil stosowany do montażu bez profilu aluminiowego w wyfrezowanym kanale.

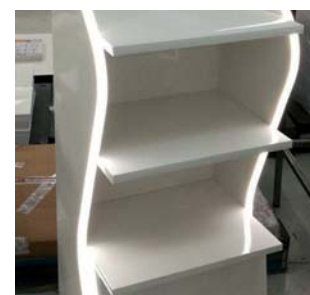

Elastyczny dyfuzor do LED 90°

Art.	Materiał	Wymiary
015.100.005	PCW	15,2 x 8 mm

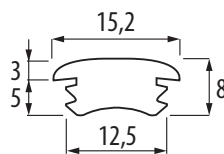

Profil do dyfuzora LED

Art.	Materiał	Wymiary
015.100.014	Aluminium	21,2 x 10,5 mm

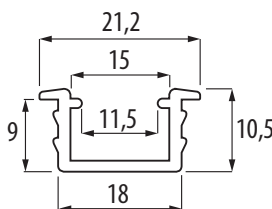

Elastyczny dyfuzor do LED

Art.	Materiał	Wymiary
015.100.006	PCW	13,6 x 7 mm

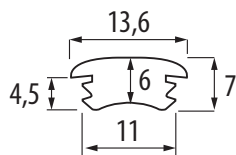

Profil do dyfuzora LED

Art.	Materiał	Wymiary
015.100.024	PCV	26 x 18 x 14,2 mm

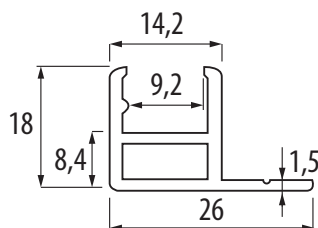

Elastyczny dyfuzor do LED

Art.	Materiał	Wymiary
015.100.048	PCW	14,5 x 14 mm

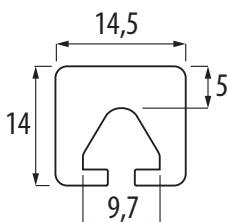

Profil do dyfuzora LED

Art.	Materiał	Wymiary
015.100.009	Aluminium	14 x 7 mm
015.100.035	Magnes	14 x 7 mm

Profil i magnes

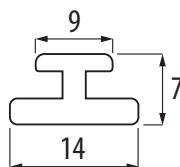

Elastyczny dyfuzor LED

Art.	Materiał	Wymiary
015.100.054	PCW	7,5 x 15,5 mm

Uwaga. Stosowany bez profilu w frezowanym kanale.
Stosowany z ledami świecącymi bocznie.

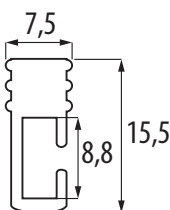

Elastyczny dyfuzor do LED

Art.	Materiał	Wymiary
015.100.027	PCW	15,4 x 8 mm
015.100.039	PCW	14 x 7 mm

Profil do dyfuzora LED

Art.	Materiał	Wymiary
015.100.021	Aluminium	25,7 x 6,36 mm

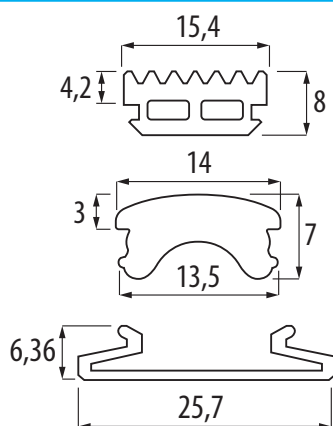

Elastyczny dyfuzor do LED

Art.	Materiał	Wymiary
015.100.058	ABS	Ø36,8 x 2 mm

Profil do dyfuzora LED

Art.	Materiał	Wymiary
015.100.009	Aluminium	14 x 7 mm
015.100.035	Magnes	14 x 7 mm

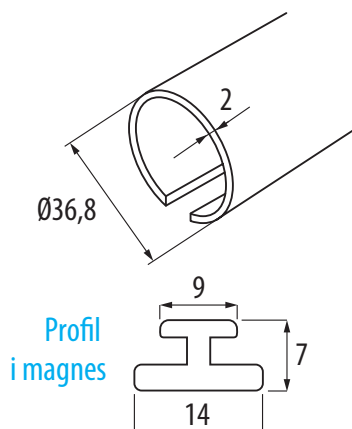

Elastyczny dyfuzor do LED

Art.	Materiał	Wymiary
015.100.049	ABS	19 x 9 mm

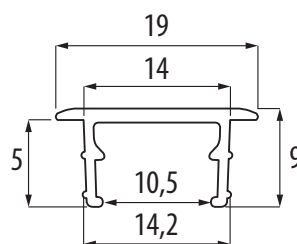

Profil do dyfuzora LED, samoprzylepny

Art.	Materiał	Wymiary
015.100.050	Aluminium	12 x 3 mm

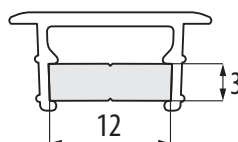

Elastyczny dyfuzor do LED

Art.	Materiał	Wymiary
015.100.052	ABS	30 x 17,5 mm

